

# DS104 RS LIGHT

## MANUAL DE: DS104, RS LIGHT.



Mecanismo de control para alumbrado residencial. Este dispositivo puede ser usado como pulsador, conmutador y cruzamiento

### OPCIONES DE CONEXIÓN

PULSADOR:

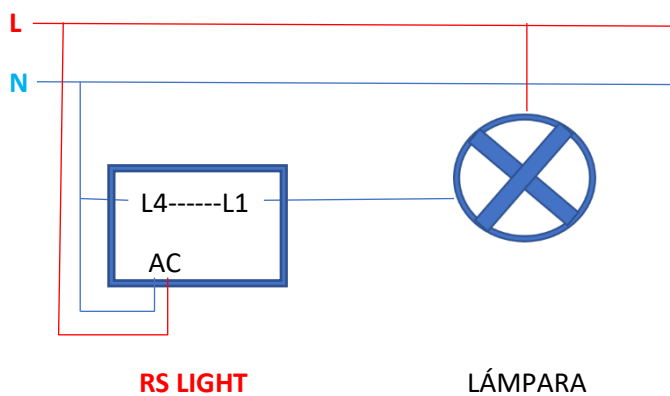

CONMUTADOR:

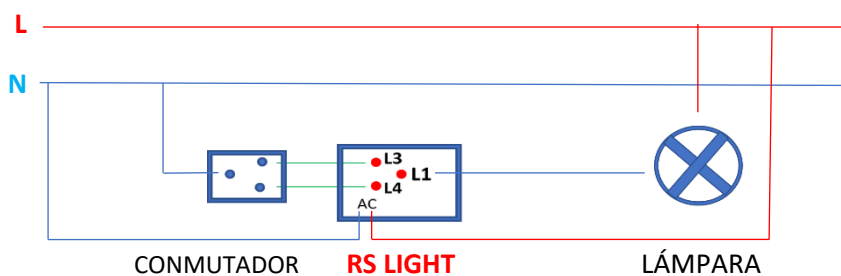

# DS104 RS LIGHT

CRUZAMIENTO:

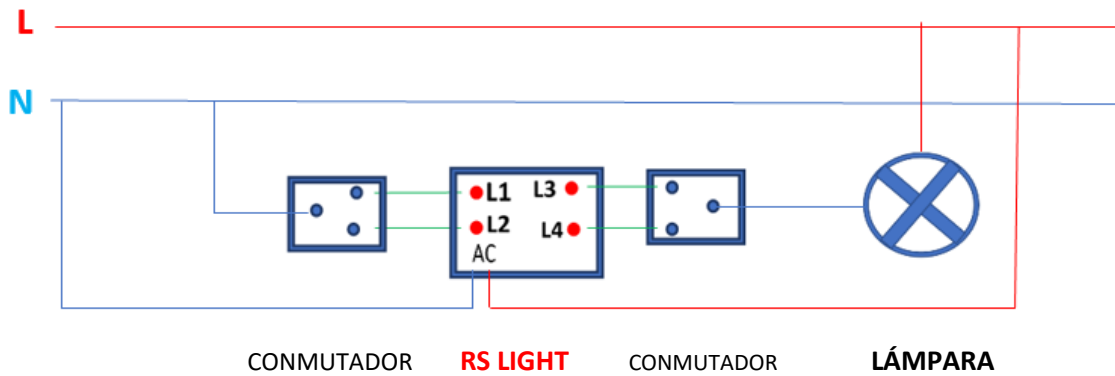

**Nota:** no importa los cruzamientos que haya instalados.

PROGRAMAR EL DISPOSITIVO CON WIFI:

## 2. Programar el dispositivo con wifi

1- Descargue la APP "DASPI" desde:

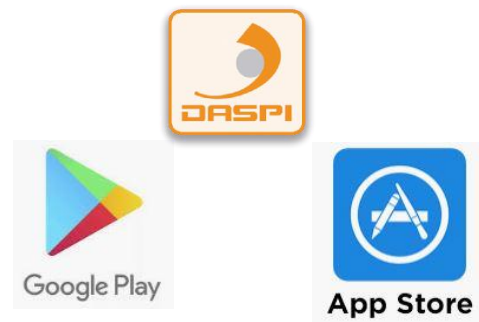

2- Crear una cuenta nueva.



# DS104 RS LIGHT

3- Añade un dispositivo.

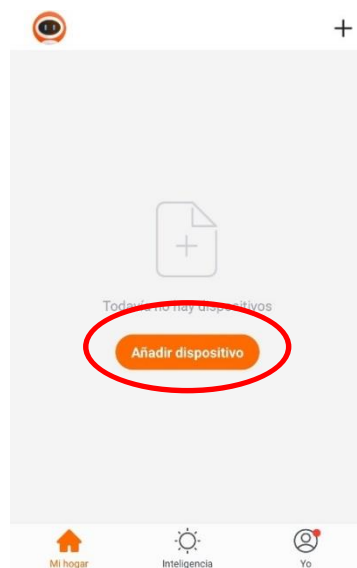

4-Seleccionar tipo de dispositivo a añadir, en este caso “RS Light Daspi”

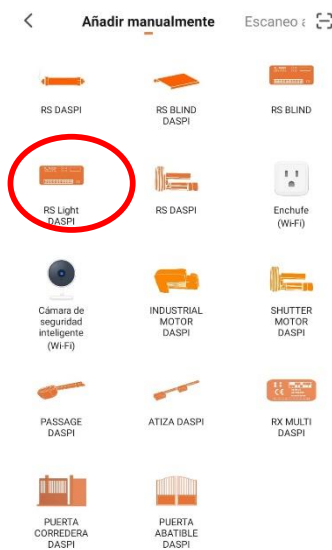

5-Primero comprobar que el dispositivo está conectado a la corriente eléctrica, a continuación, pulsar “la luz de confirmación en el flash”

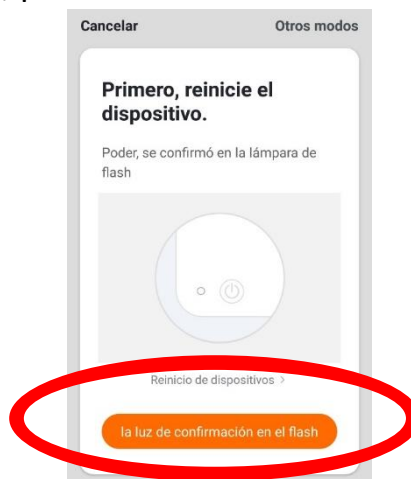

# DS104 RS LIGHT

6- Conectar el móvil al wifi con el que vaya a trabajar el receptor.



7- Introducir en la APP la red wifi y la contraseña para confirmarle al receptor dónde queremos que se conecte. Pulsar confirmar.

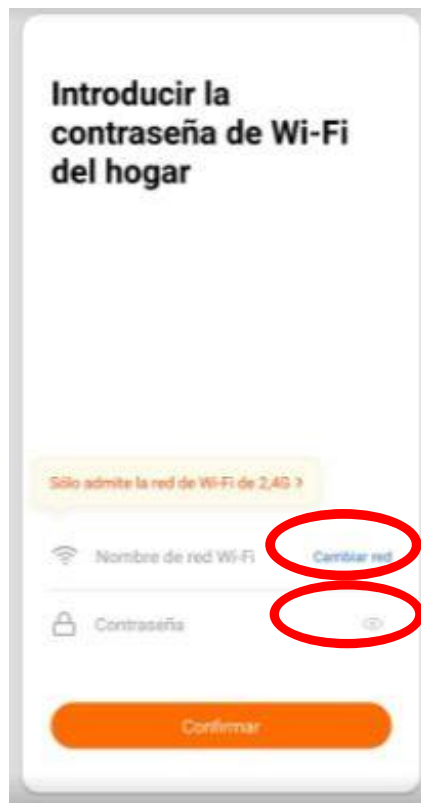

8- Mantener pulsado en el motor el botón "S1" durante unos segundos hasta que el led rojo parpadee



# DS104 RS LIGHT

---

9- El receptor se agregó correctamente. Pulse **“Finalizado”**



10- Una vez agregado podremos controlar las maniobras desde el dispositivo móvil.



# DS104 RS LIGHT

## 3. Añadir un usuario

3.1. seleccionamos "editar"

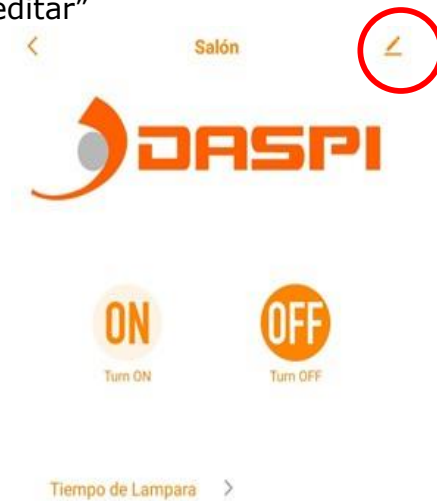

3.2 seleccionamos "compartir equipo"

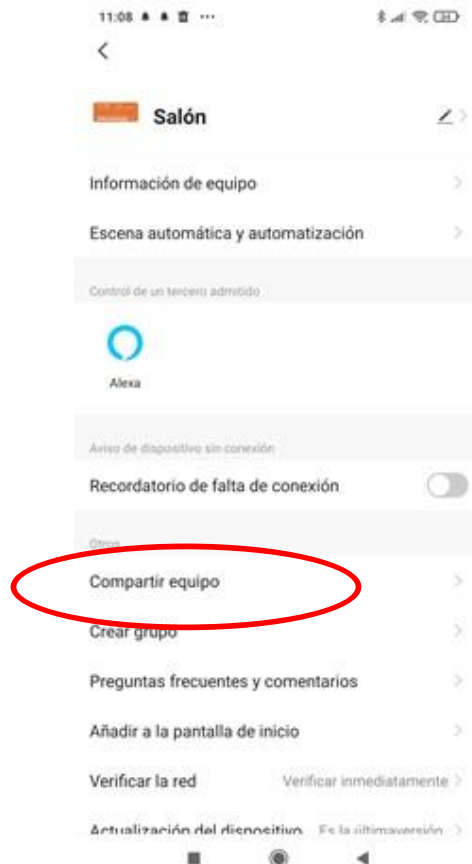

# DS104 RS LIGHT

## 3.3 seleccionamos "añadir lo compartido"

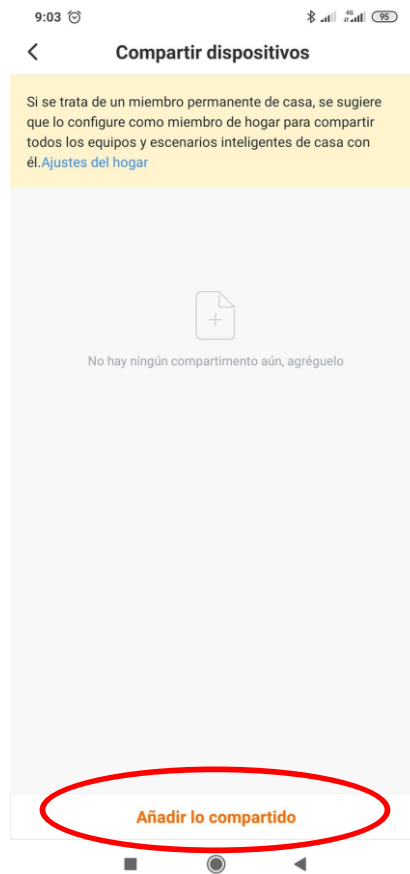

## 3.4 introducimos país y número de teléfono

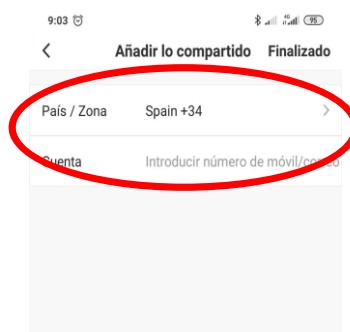

## 3.5 seleccionamos "Finalizado"

# DS104 RS LIGHT

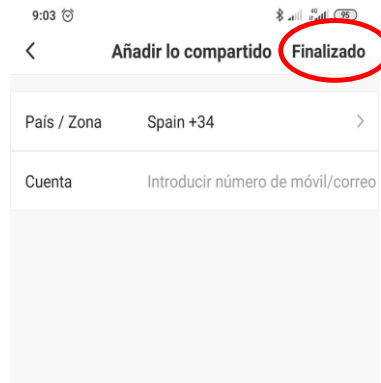

## 4. Imagen detalle

Ubicación de LEDs y botones.

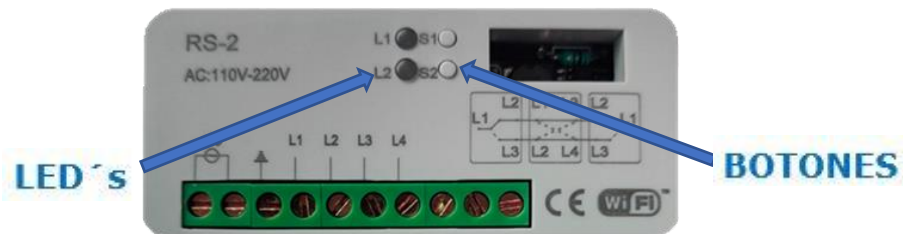

## 11. Conectar tu dispositivo con Amazon Alexa y Apple Siri:

Para conocer como vincular tu dispositivo has clic en Siri o Alexa y conoce a detalle el proceso de vinculación.



¡HEY SIRI!



amazon alexa



# DS104 RS LIGHT

## MANUAL FOR THE DS104, RS LIGHT.

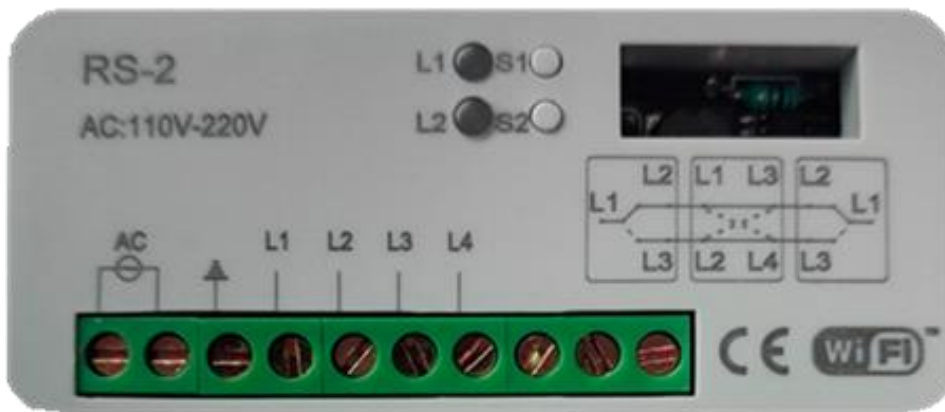

Control mechanism for residential lighting. This device can be used as a pushbutton, switch and crossover.

### CONNECTION OPTIONS.

Pushbutton:

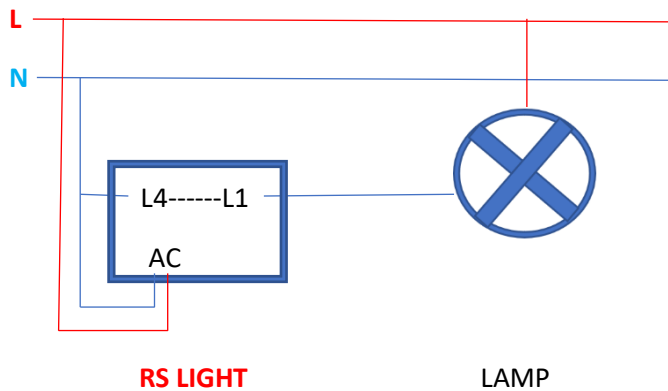

SWITCH:

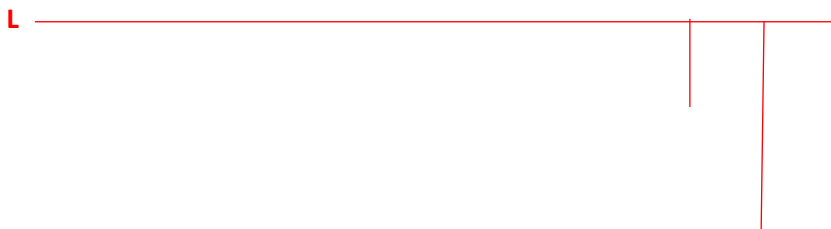

# DS104 RS LIGHT

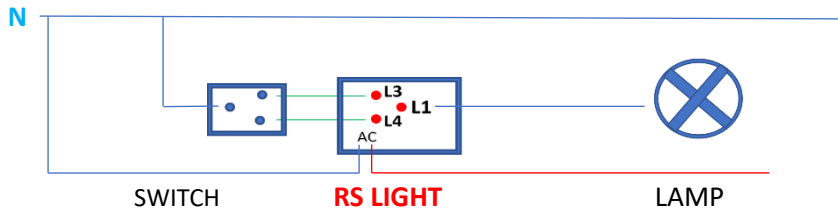

CRUZAMIENTO:

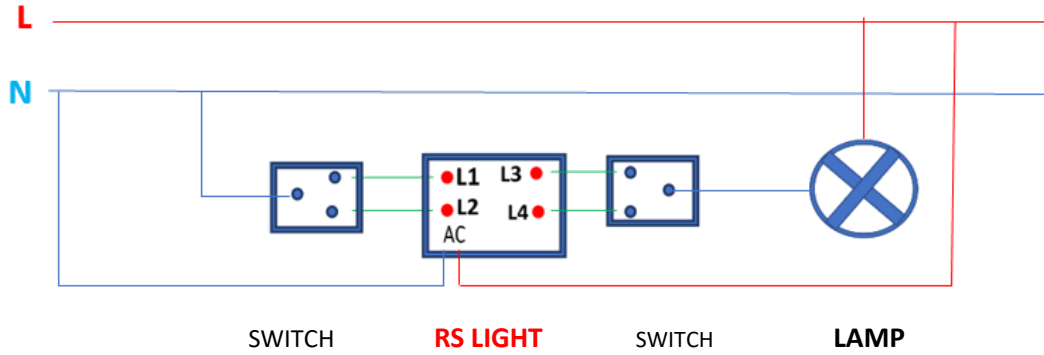

**Note:** it does not matter which crosses are installed.

## 2. Linking a device with the Rs Light.

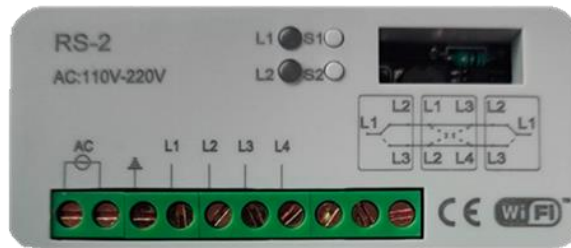

1- Download the "DASPI" App



on:



2- Create an account:

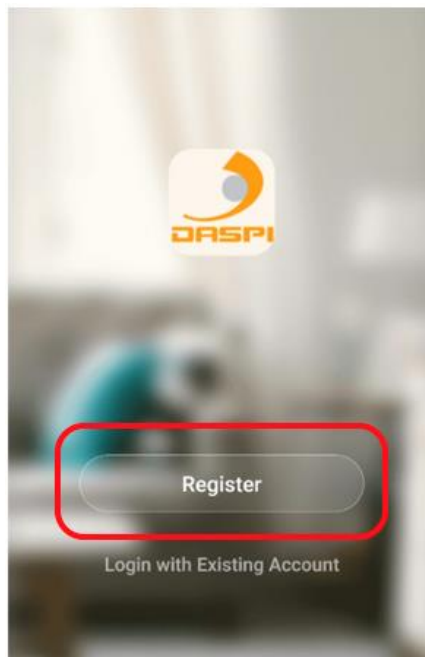

# DS104 RS LIGHT

3- Press on “Add Device”

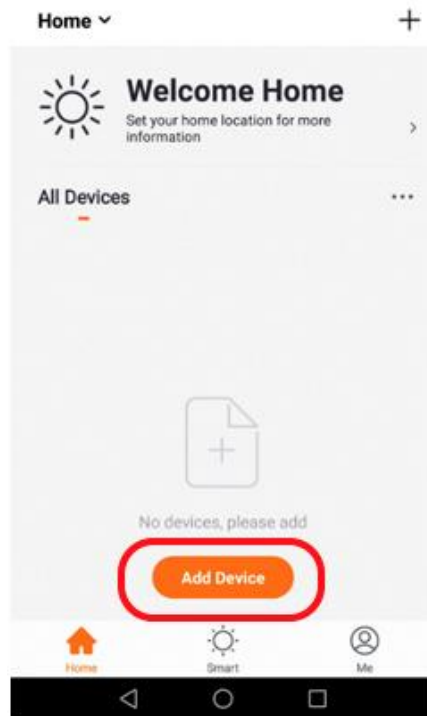

4- Choose the kind of device to be added. In this case: “RS Light Daspi”

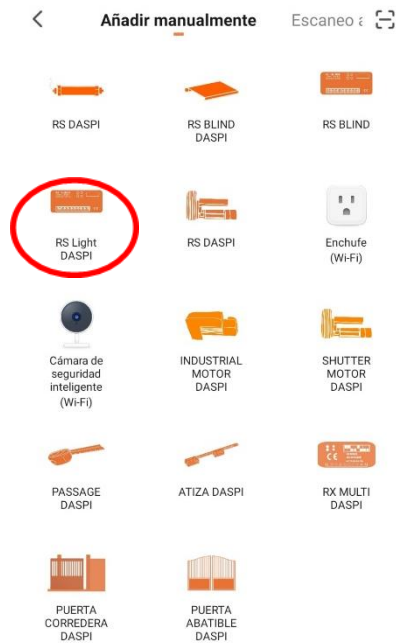

## DS104 RS LIGHT

---

5- Check the device is connected to the power and them press on **“Confirm indicator rapidly blink.”**

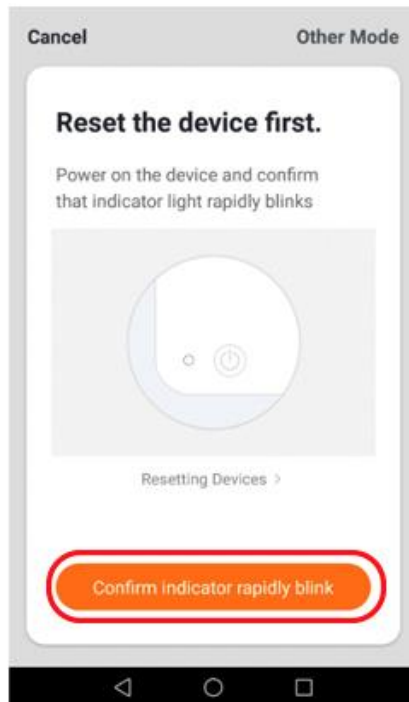

6- Connect your phone to the Wi-Fi network the receiver will work with.

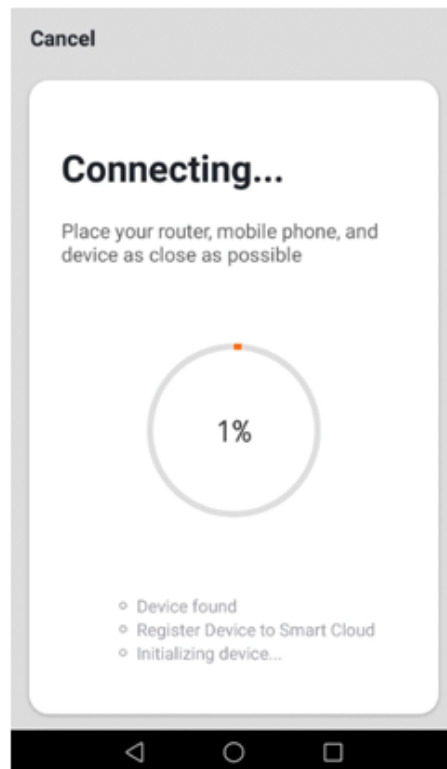

## DS104 RS LIGHT

---

7- Choose the Wi-Fi network on the App and introduce the password to let the receiver what network should use. Press **“Confirm”**.

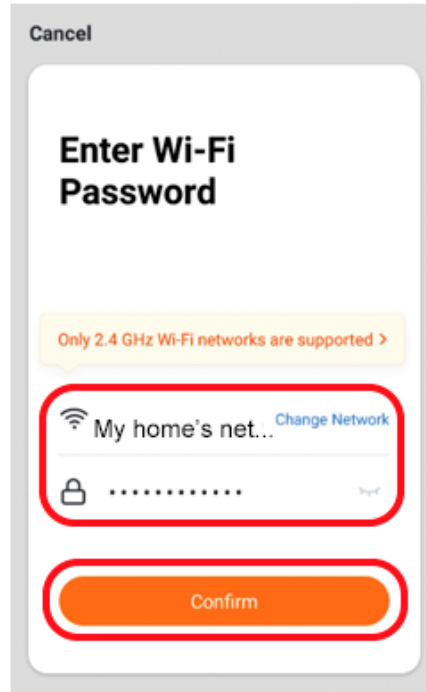

8- Keep pressed the button “S1” on the receiver for few seconds until the red LED starts flashing.



9- The receiver has been correctly added. Press **“Done”**

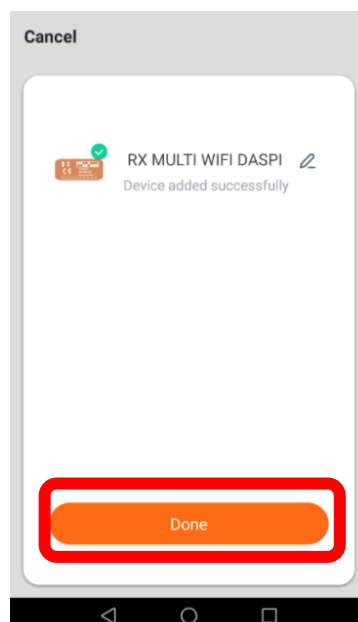

# DS104 RS LIGHT

10- Once the receiver has been added, we can control the device with the smartphone.

## 3. How to add another user.

3.1. Select on "edit"

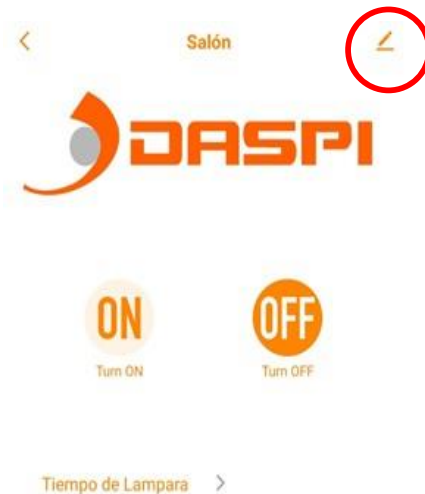

3.2 Now choose the option listed as "share device"

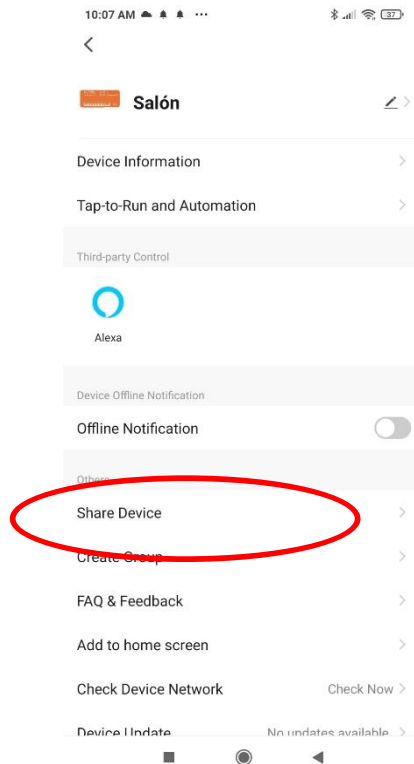

# DS104 RS LIGHT

## 3.3 Select "add sharing"

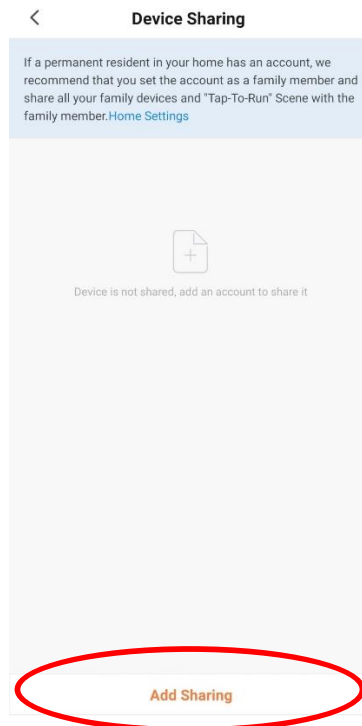

## 3.4 Here you have to enter the region and phono number of the user

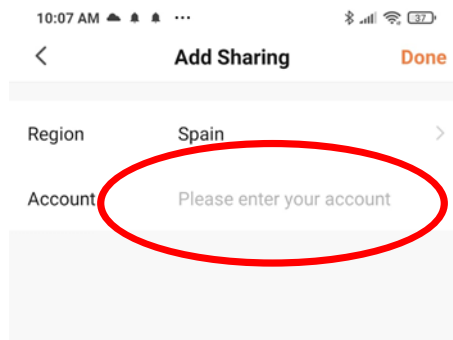

## 3.5 Click on "Done" to finish.

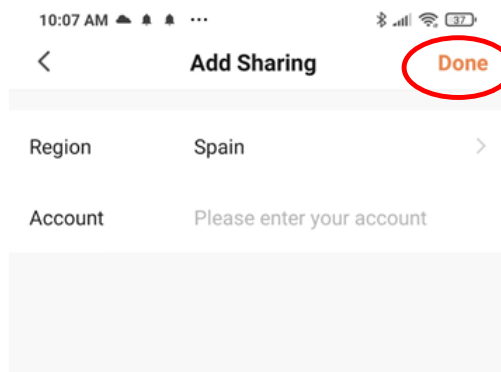

# DS104 RS LIGHT

---

## 4. Picture of the product

Location of the LEDs and buttons.

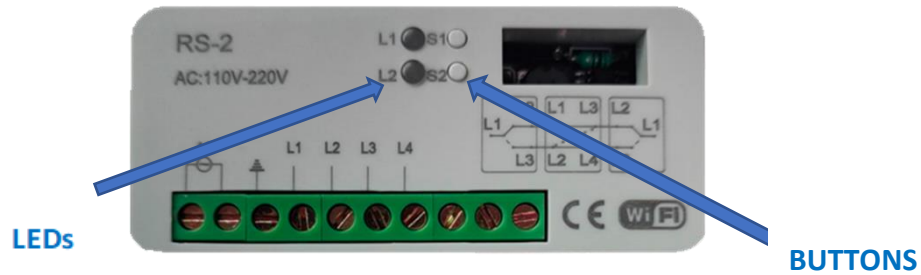

## 5. Connect your device with Amazon Alexa and Apple Siri:

To know how to connect your device click on Siri or Alexa and see each detailed step on the linking process.



HEY SIRI!



amazon alexa